

Olympus Playset

ASSEMBLY MANUAL



PATIOVA.COM

610-857-1359

6649 North Moscow Rd
Parkesburg, PA 19365





Thank you for your Patiova Playset Purchase.

We are excited for the great times and memories you will share while enjoying your new Patiova playset.

Let's gets started on the assembly!!

This manual is designed to simplify the assembly process with step-by-step instructions and pictures to help along the way.

We recommend you have carpenter experience or hire a carpenter to assemble your playset to ensure safety when complete.

We are confident that you will be happy with the ease of the assembly process.

Tools Required

- Hammer or Rubber Mallet
- Wrench & Socket Set
- Drill and Drill Bits
- Impact Driver
- Tape Measure
- Step Ladder
- Level

Tools Included

- #2 Square Drive Bit
- T30 Star Drive Bit
- 5/32 Hex Drive Bit

Parts List

Tower	
Type	Quantity
Floor Section	1
Side Walls	2
Ladder Section	1
Cargo Net Section	1
68" 2x8	2
4x4 Braces	4
46" 2x6's	2
59 2x4's	2

Wood Roof	
Roof Side Panels	2
Sunburst Piece	2

Swing Frame	
2x6 Swing Beam	1
4x4 Legs	2
2x6 Brace	1
2x4 Brace	1
Support Brackets	2

Tarp Roof	
Side 2x4's	2
Top 2x4	1
Half Moon Pieces	2
Tarp Roof	1

Hardware

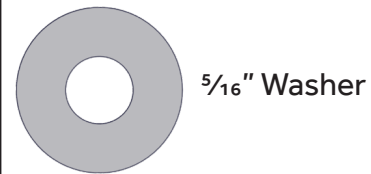
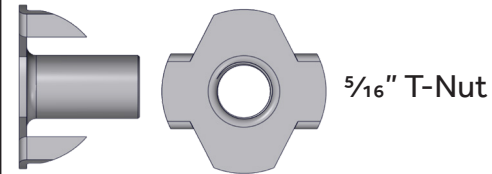
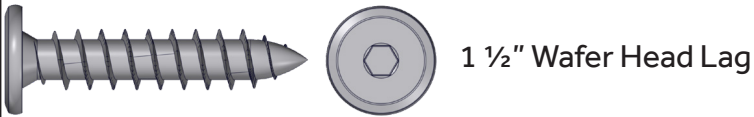
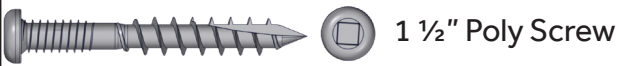
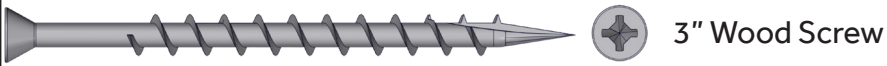
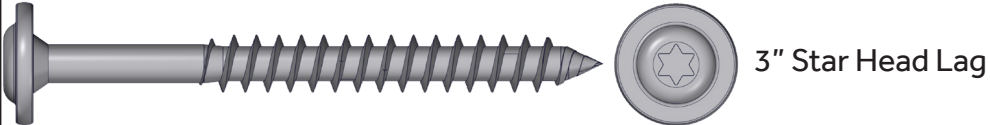
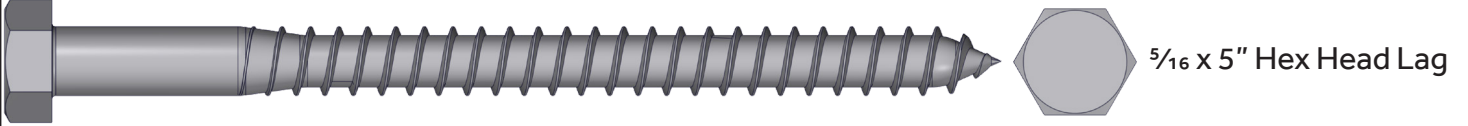

1

2

3

4

5

6

7

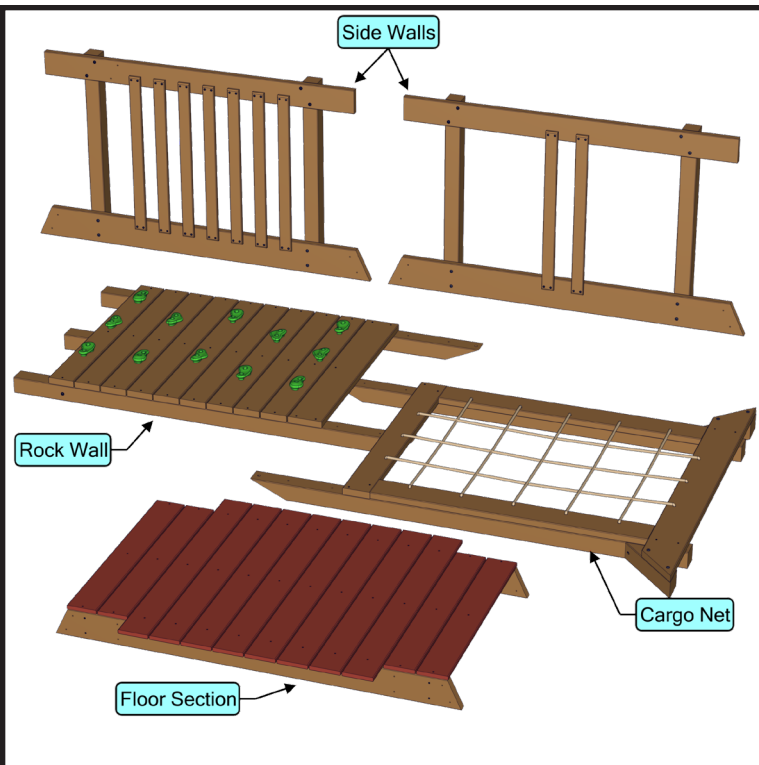

Step 1.
Begin the assembly by locating these components.

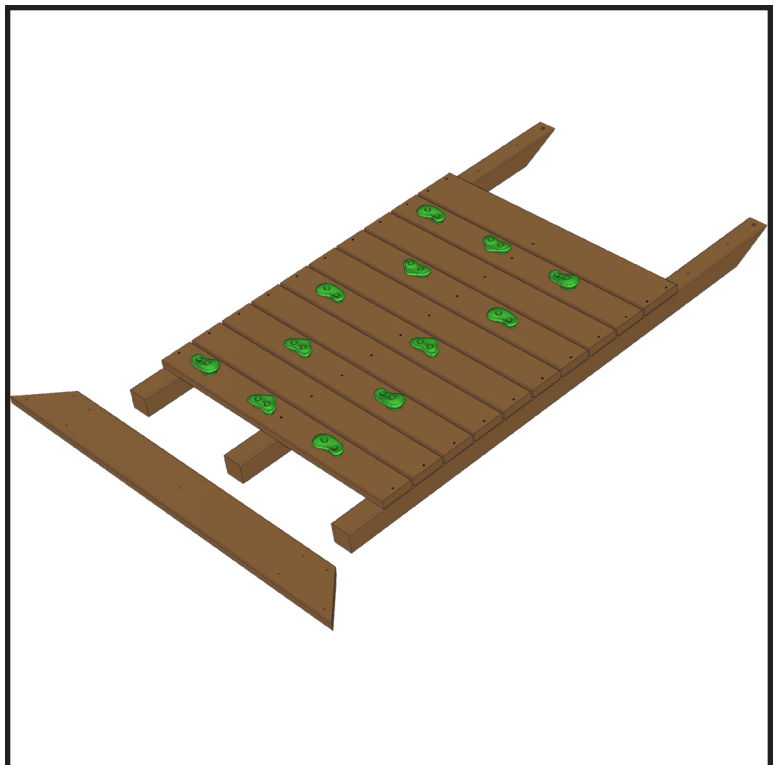

Step 2.
Start the assembly with the rock wall and a 68" 2x8.

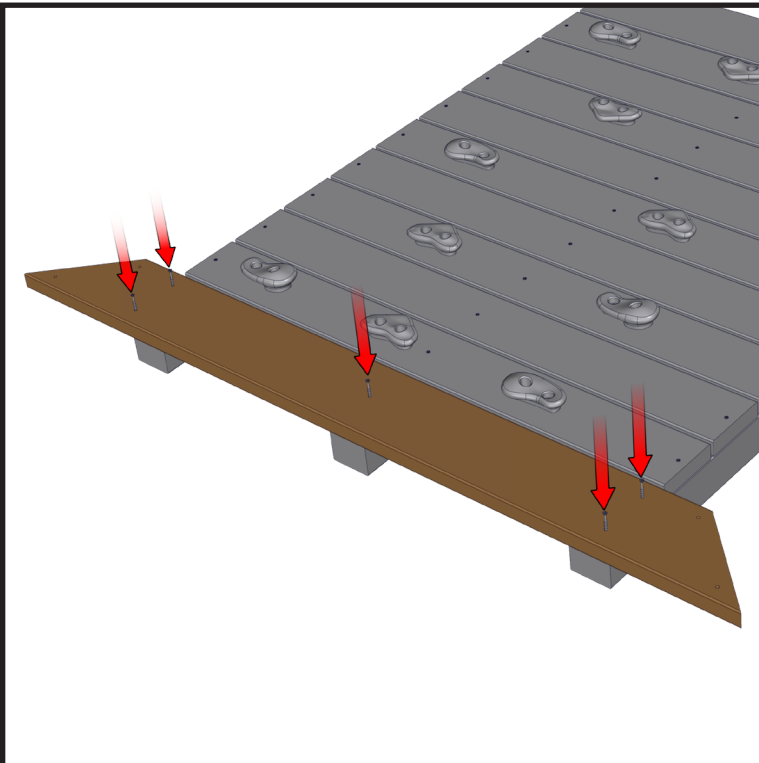

Step 3.
Place the 68" 2x8 on the bottom of the rock wall and center it. Fasten it with 3" wood screws.

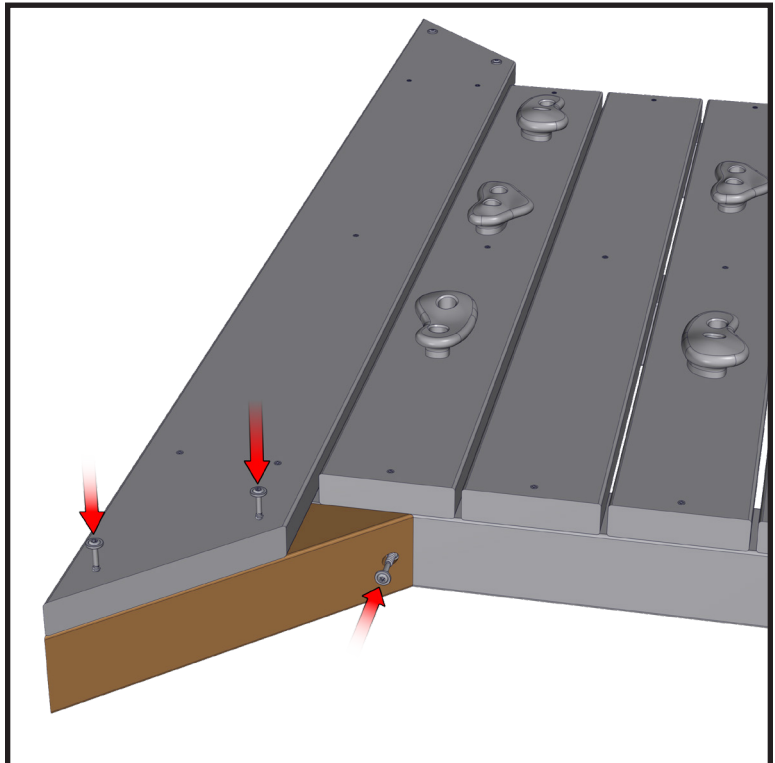

Step 4.
Place a 4x4 brace at each end of the 68" 2x8 as shown above. Fasten it with 3" star head lags.

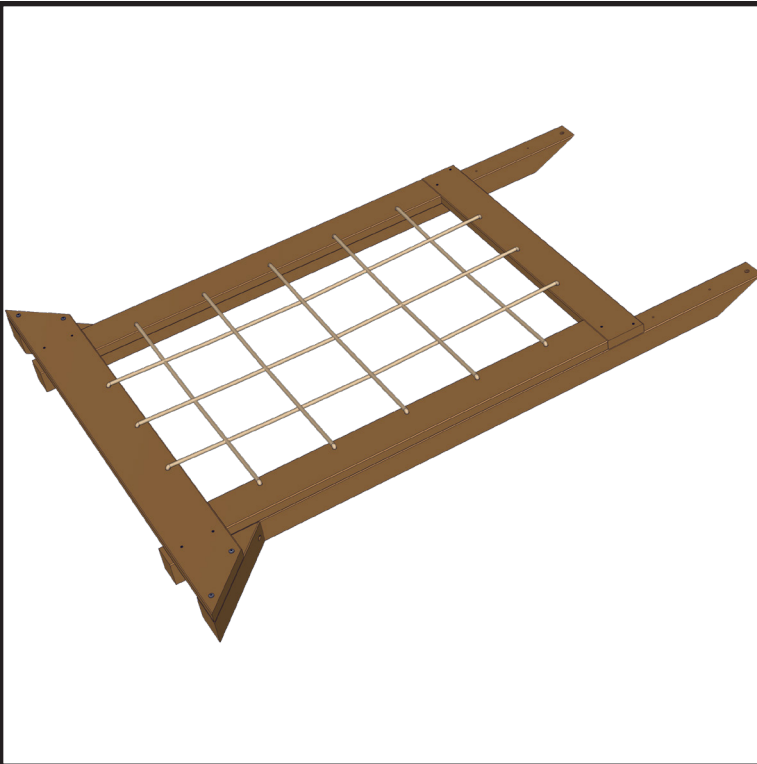

Step 5.
The cargo net should shipped assembled.

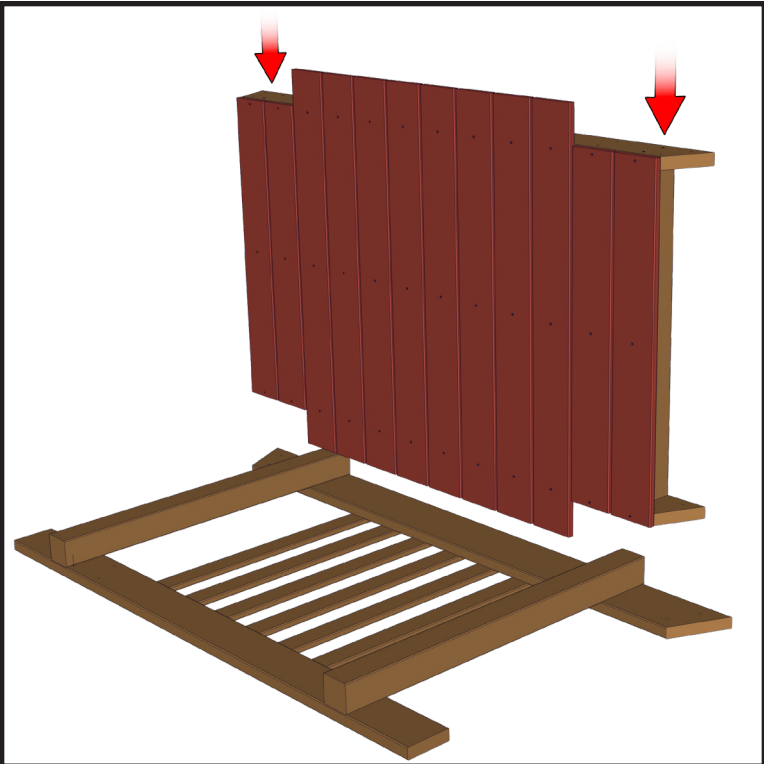

Step 6.
Place the floor section on one of the side walls as shown above then center the wall between the floorboards.

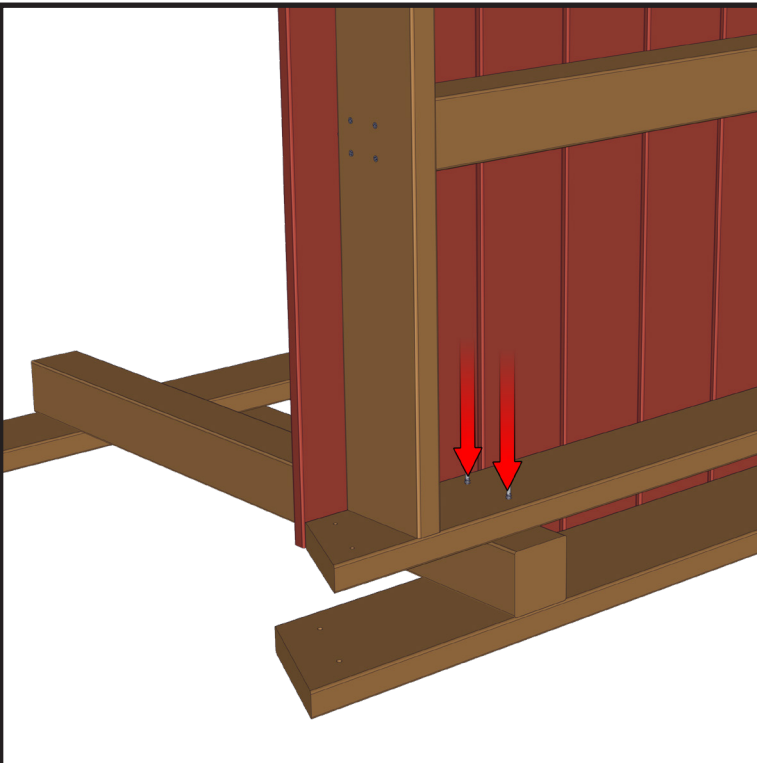

Step 7.
Fasten the floor section to the side wall using 3" star head lags through the inside 2x6's.

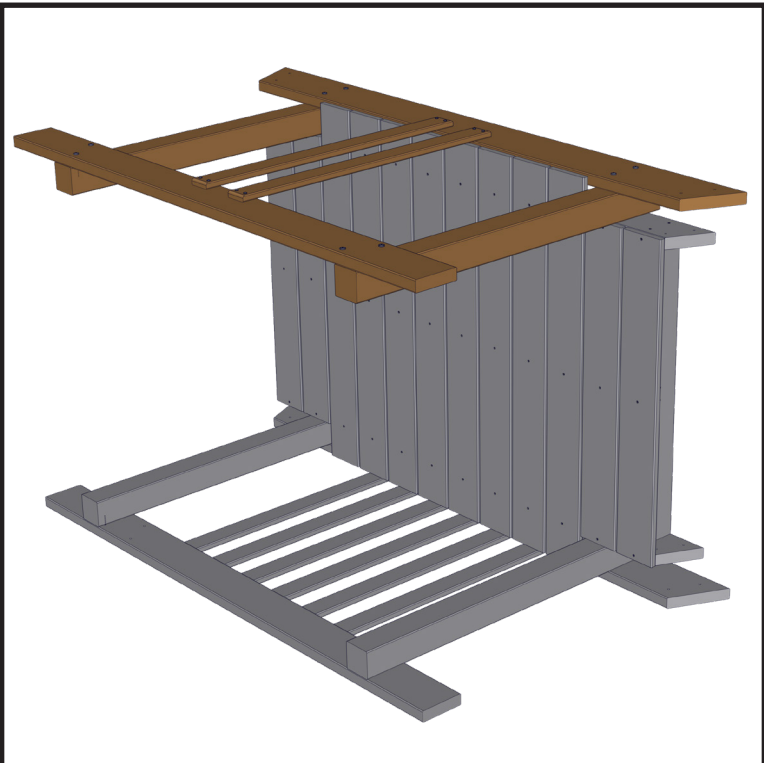

Step 8.
Place the other side wall on the floor section and use the same 3" star head lags to fasten it.

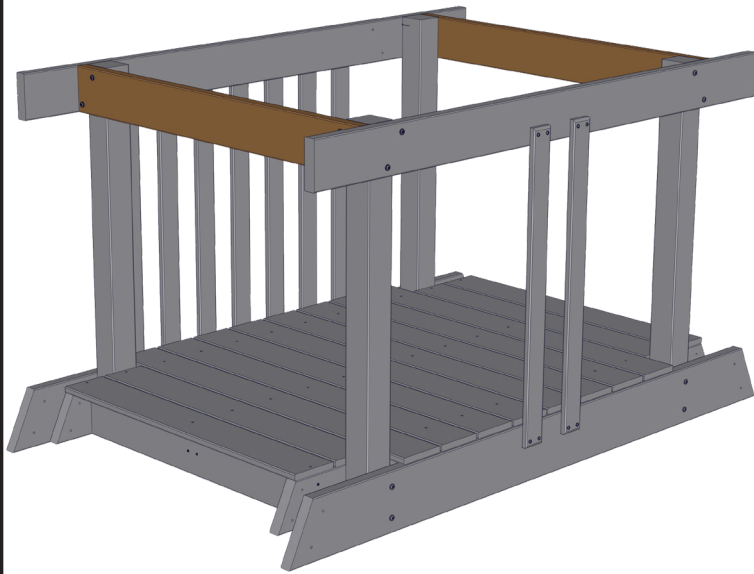

Step 9.

Place the tower upright then locate two 46" 2x6's and place them between the two side walls on the outside of the 4x4 posts. Fasten them to the 4x4 posts using 3" star head lags.

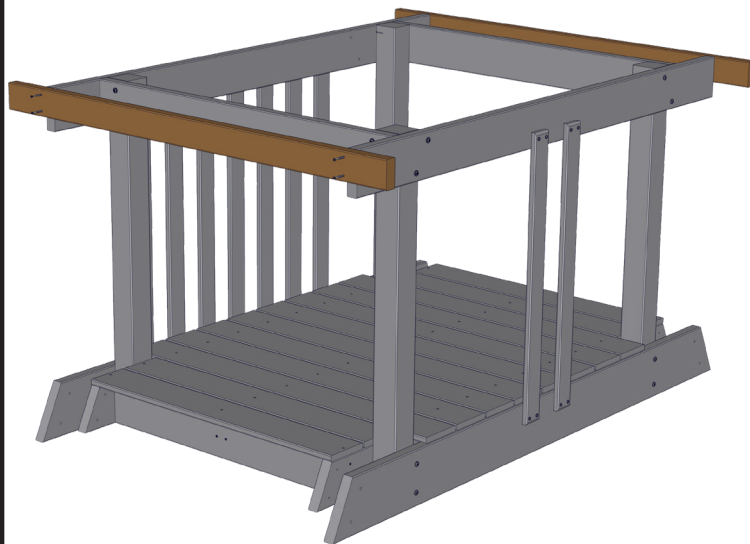

Step 10.

Place two 59" 2x4's on either side of the 2x6 railings and fasten them using 3" wood screws.

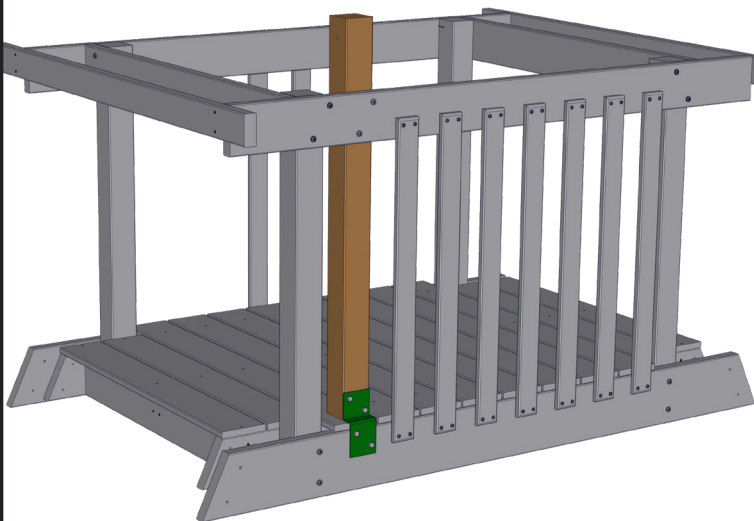

Step 11.

Locate the 44" 4x4 post and place it in the empty spot between the poly slats. Fasten the bottom of the post with a bracket and four hex head lags.

Note: If your playset has a space saver swing beam, you will not need this 4x4.

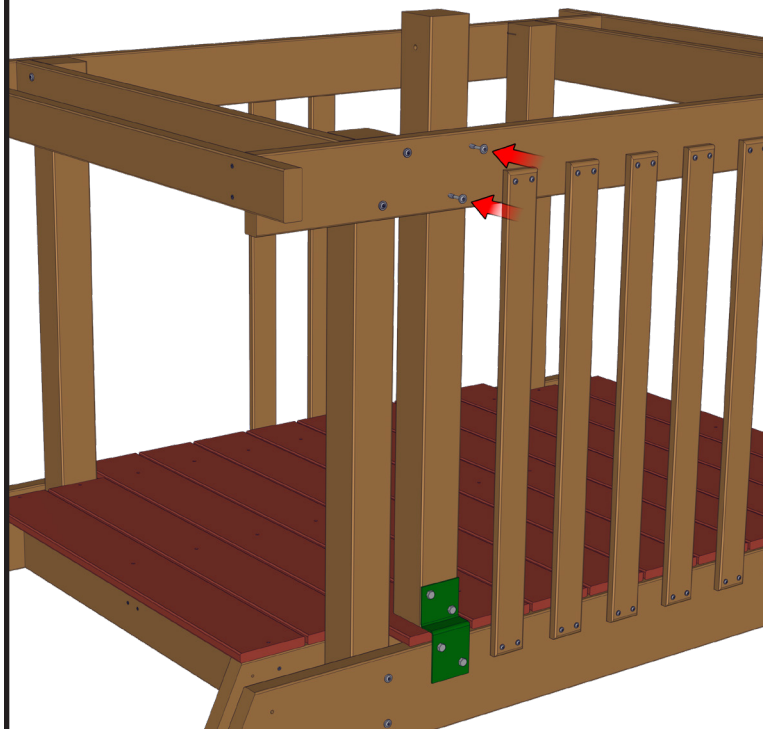

Step 12.

Fasten the top of the post with two 3" star head lags.



Step 13.

Raise one side of the floor section and place the cargo net underneath.

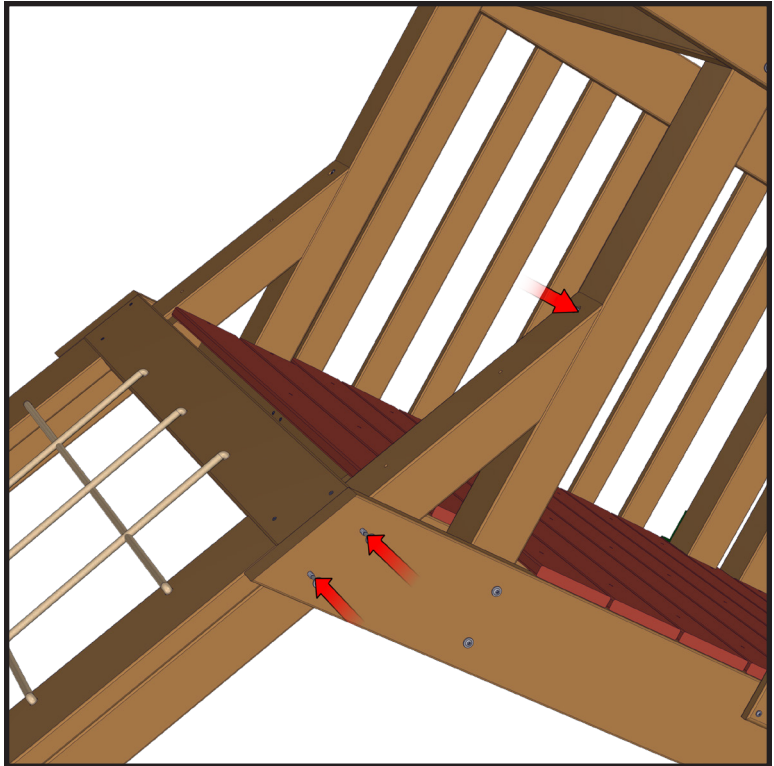

Step 14.

Fasten the ladder using two 3" star head lags through the side 2x8 and one 3" star head lag through the top of the 4x4 post.

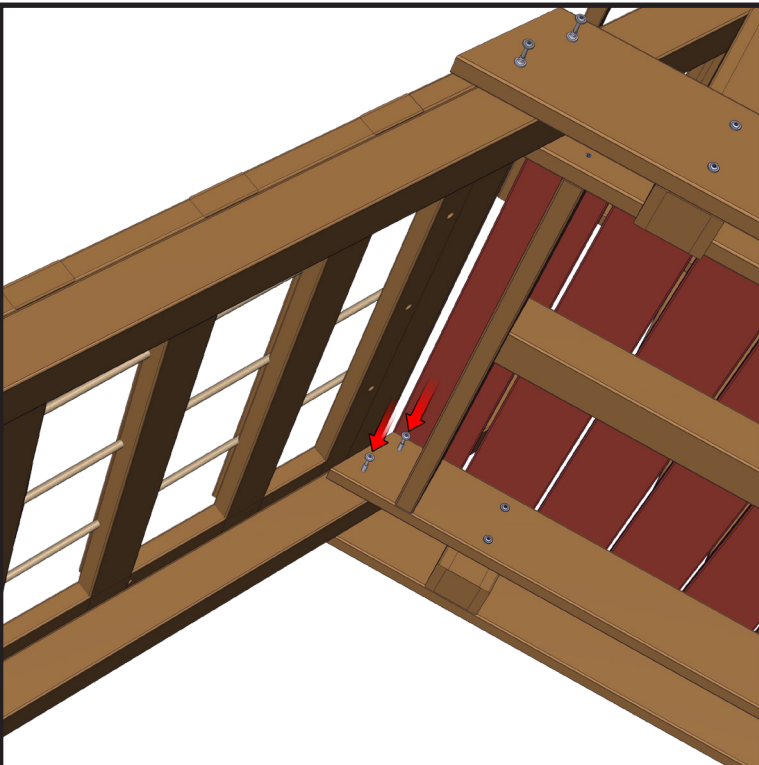

Step 15.

Fasten the inside 2x6 to the 4x4 post using two 3" star head lags.



Step 16.

Repeat the previous steps to install the rock wall.

Tarp Roof

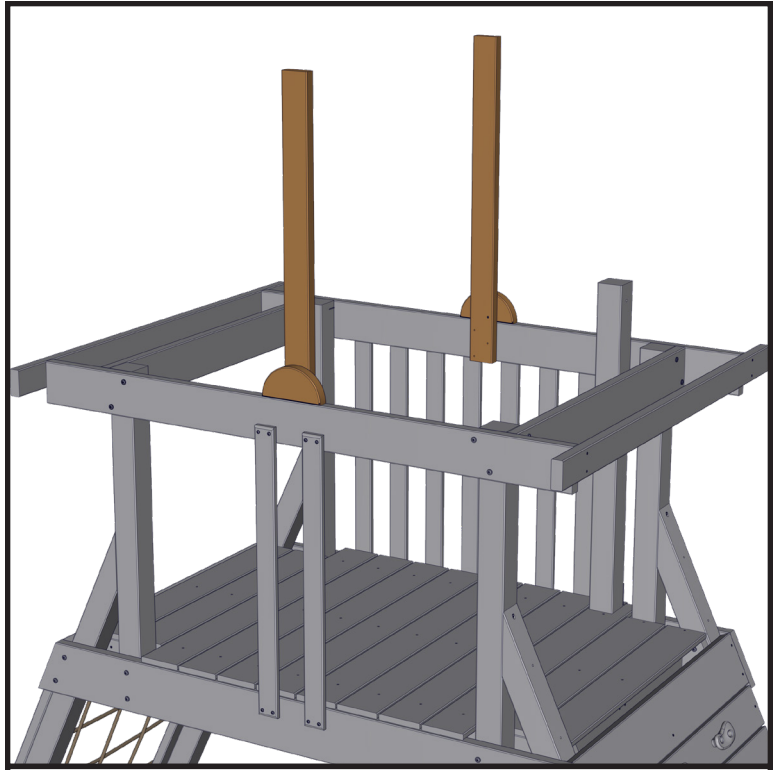

Step 1.

Locate two 2x4's with half moon pieces attached and place them on the 2x6 railings with the half moon pieces facing out. Fasten these 2x4's with 3" wood screws.



Step 2.

Place a 59" 2x4 on top of the other 2x4's and center it. Fasten it with 3" wood screws.



Step 3.

Place the tarp roof over the wood frame and stretch it to fit. Fasten both sides with 1 1/4" washer head screws.

Wood Roof

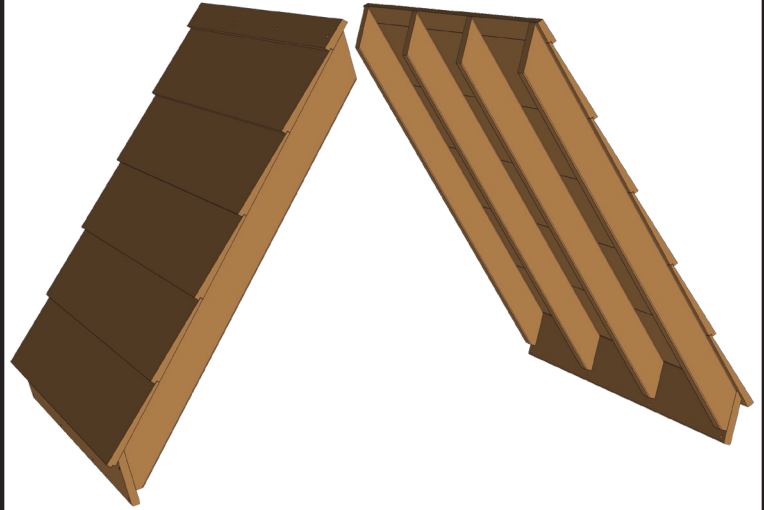
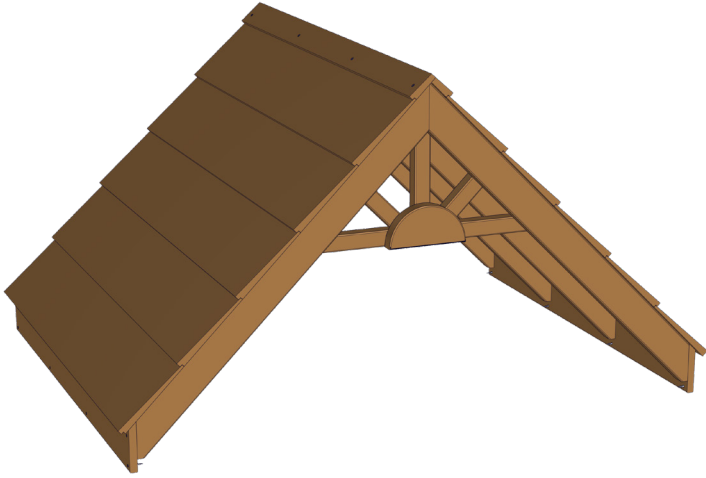

Step 1.

Locate the two side panels.

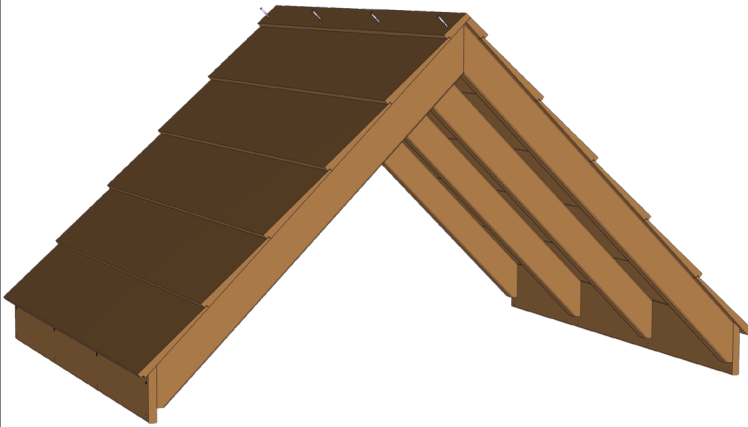

Step 2.

Place the panels together then fasten the tops together using 3" wood screws.

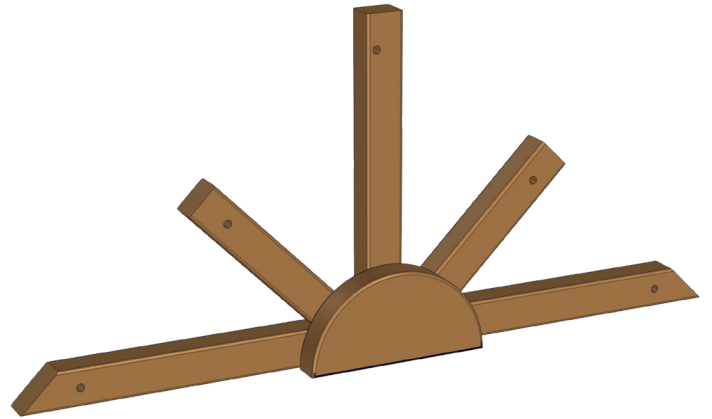

Step 3.

Locate the sunburst pieces.

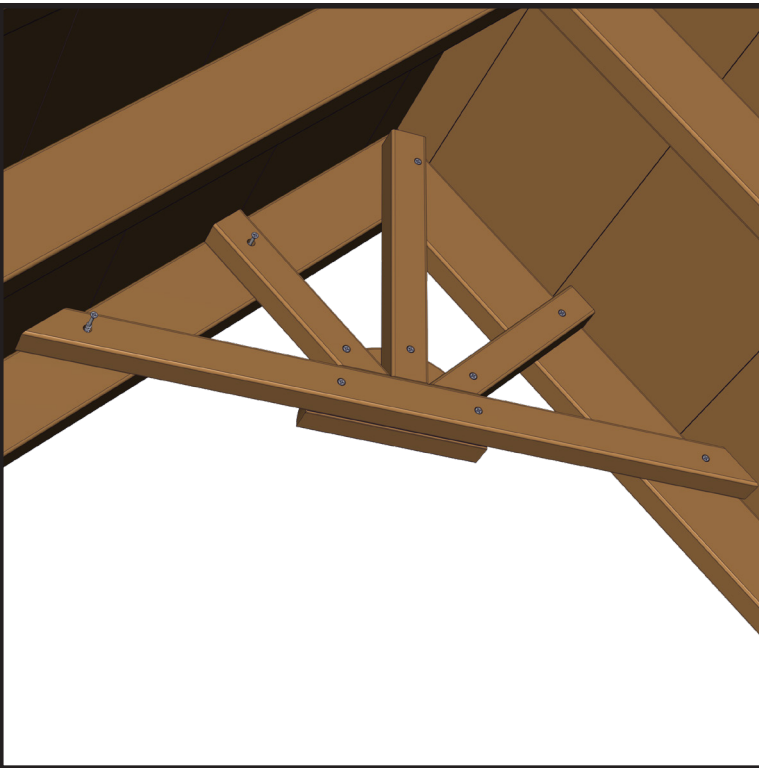

Step 4.
Place the sunburst pieces on the inside of the wood roof and fasten them with 2 ½" wood screws.

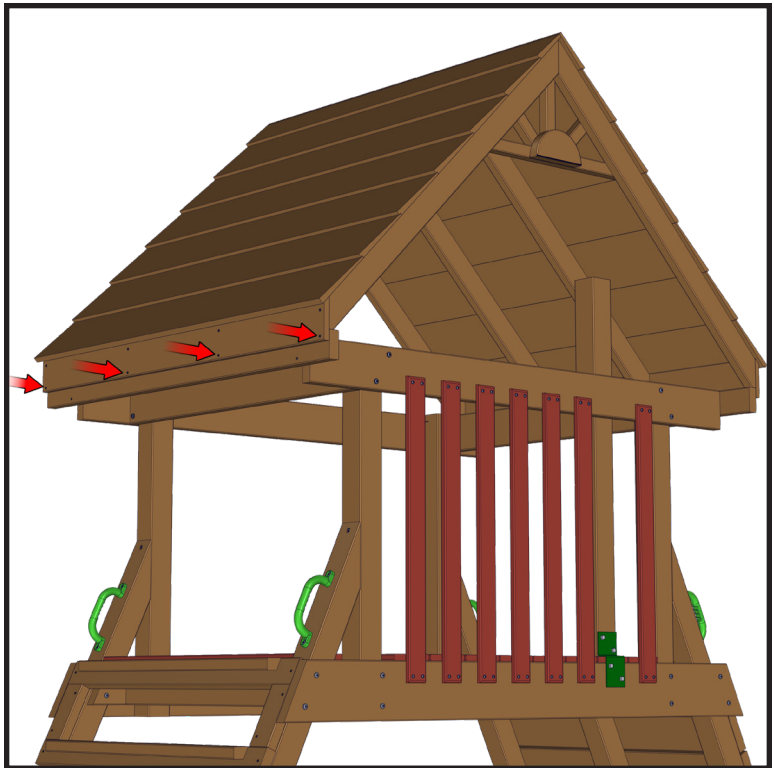

Step 5.
Place the wood roof on the tower as shown then fasten both sides with 1 ½" wood screws.



Completed Wood Roof



Standard Swing Frame

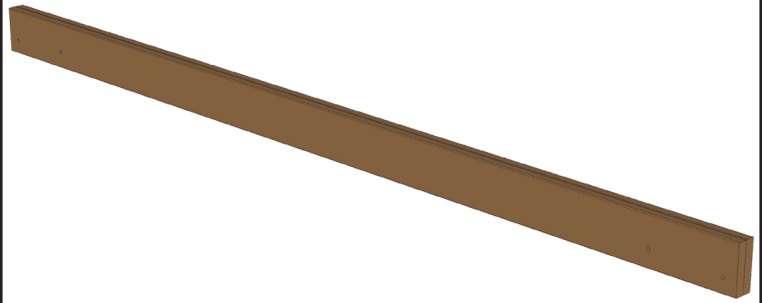
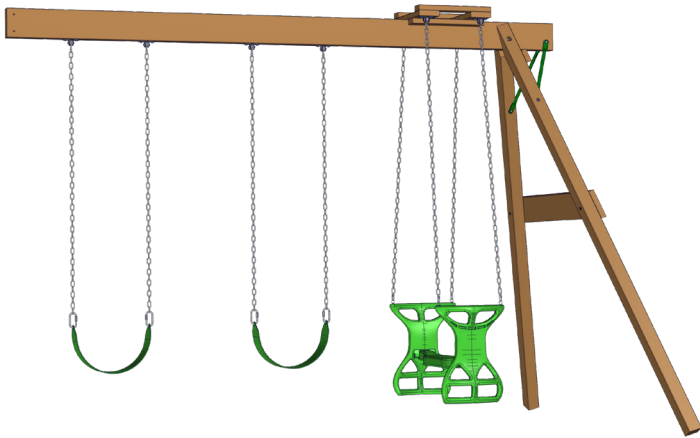

Step 1.

Locate the swing beam and place it on the ground with the pre-drilled bearing holes facing up.

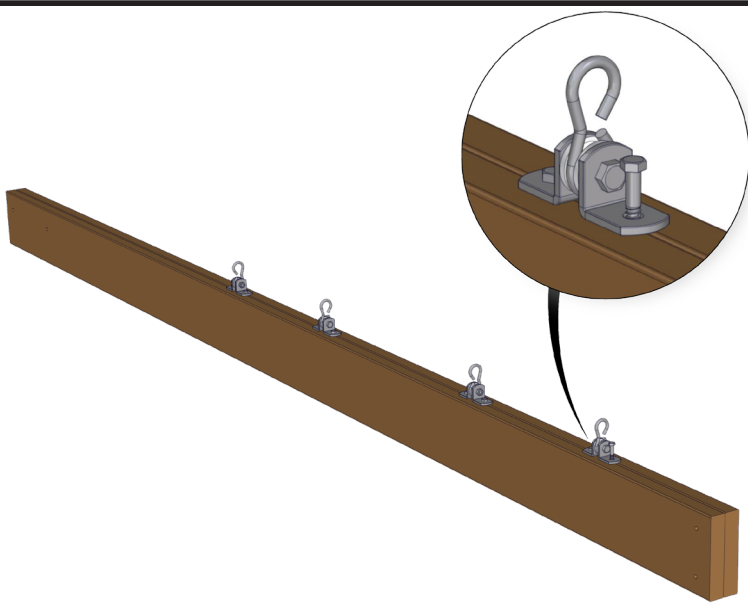

Step 2.

Fasten the swing bearings to the swing beam with the included lags in the pre-drilled holes.

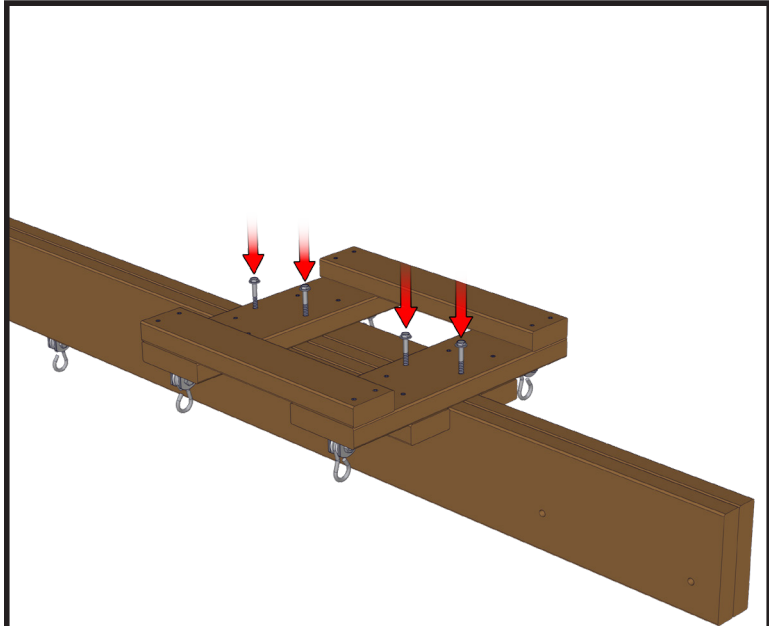

Step 3.

If your playset has a glider, place the glider bracket on the swing beam and fasten it with four washer head lags.

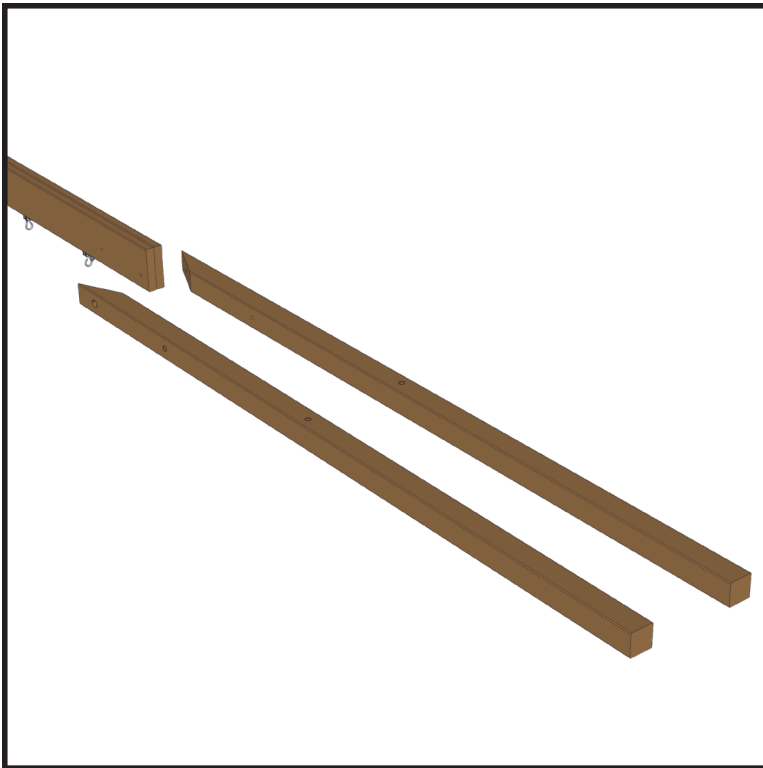

Step 4.
Place two 4x4 posts at the end of the swing beam.

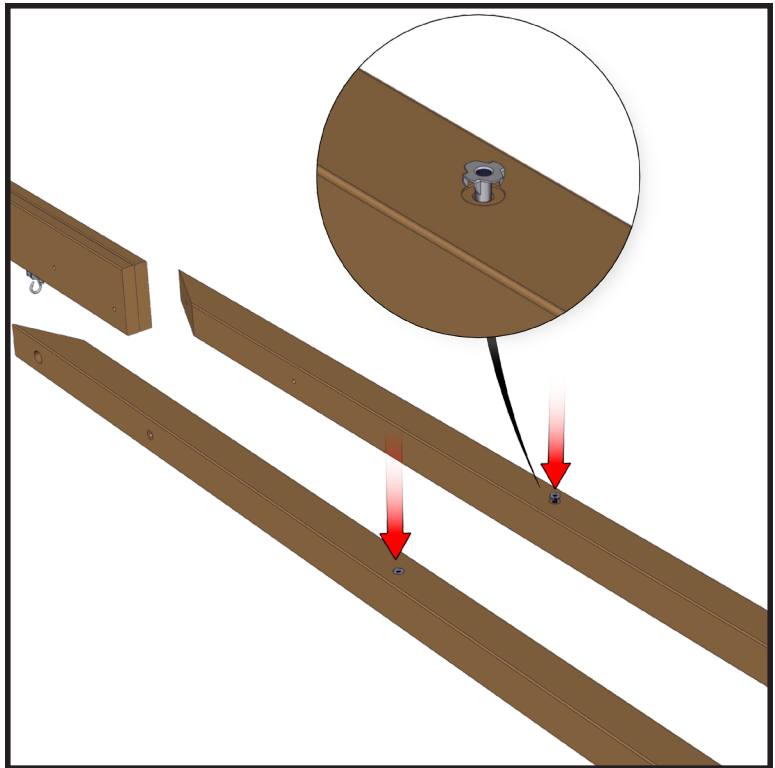

Step 5.
Place a T-Nut in each pre-drilled hole on the 4x4 posts.
Use a hammer to set them in the wood.

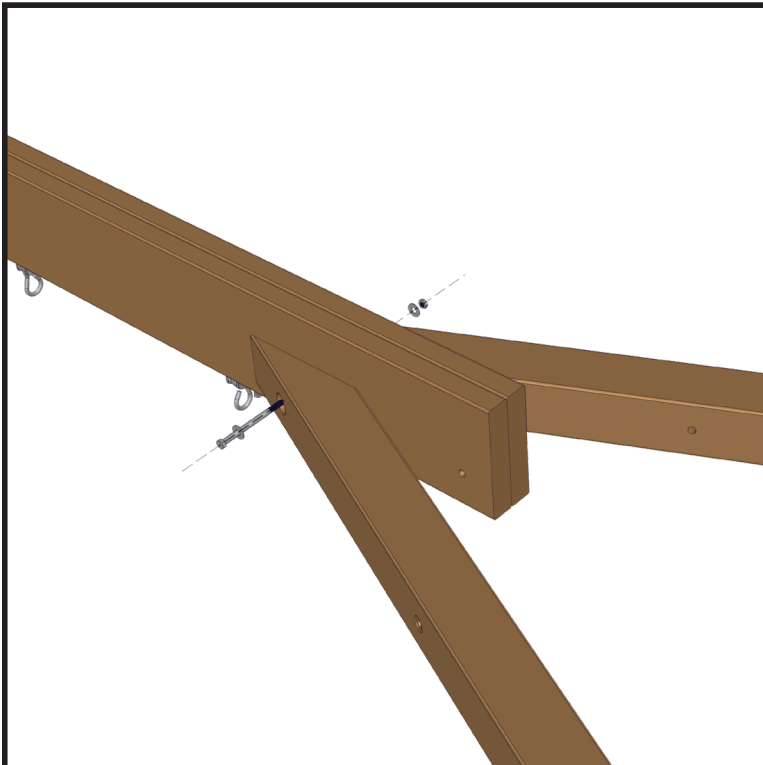

Step 6.
Flip the posts over so the T-Nuts are on the bottom then line them up with the pre-drilled holes in the swing beam.
Fasten the 4x4's to the swing beam using a 6" bolt, washers and a nut.
Do not tighten this bolt yet.

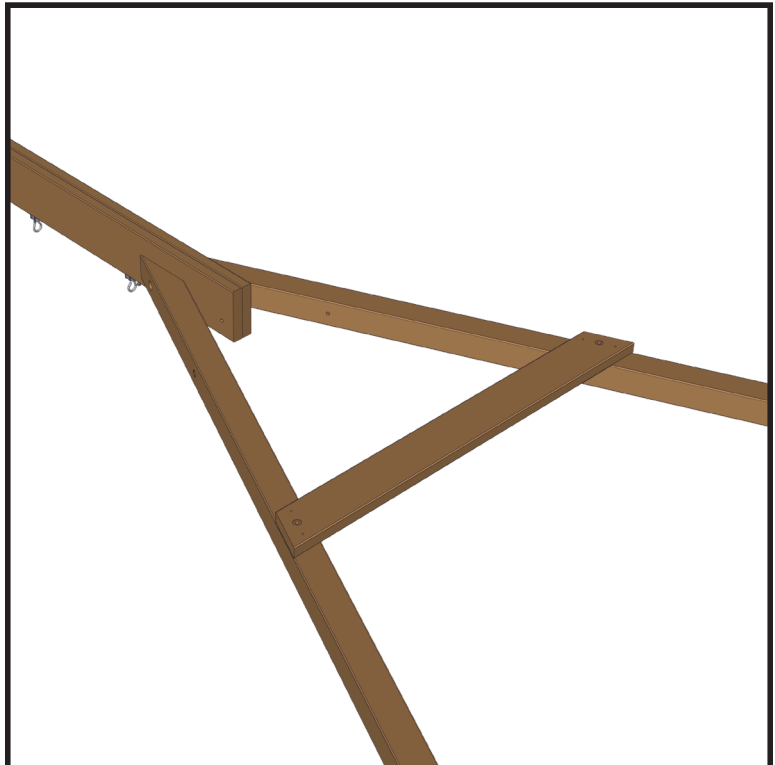

Step 7.
Place the 2x6 end piece on the posts.
Position the 2x6 so the pre-drilled holes on the posts and the 2x6 line up.

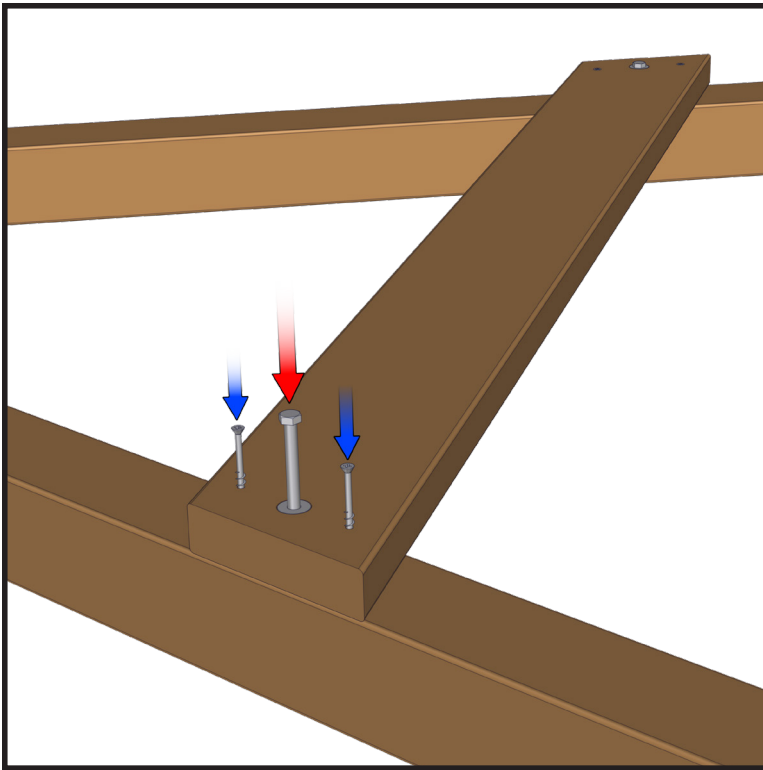

Step 8.

Fasten the 2x6 to the posts using a **4 1/2" bolt and washer**. Thread the bolt into the T-Nut below then use a 1/2" wrench or socket to tighten it. Finish fastening the 2x6 with a **3" wood screw** on either side of the bolt.

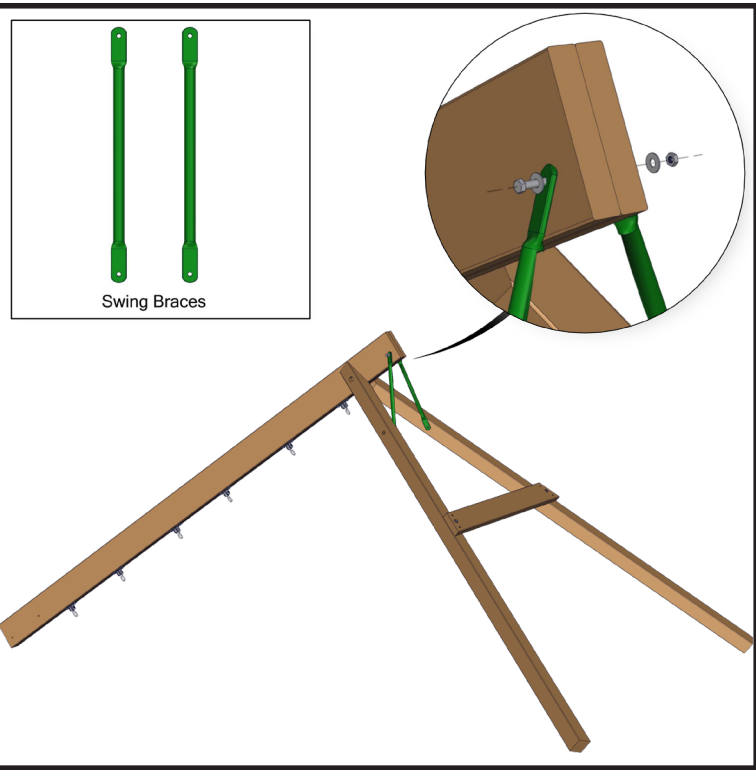

Step 9.

Raise the end of the swing frame up and move the 4x4 legs down into place. Then place two swing braces on the end of the swing beam. Fasten the swing braces using a **4" bolt, washer and a nut**.

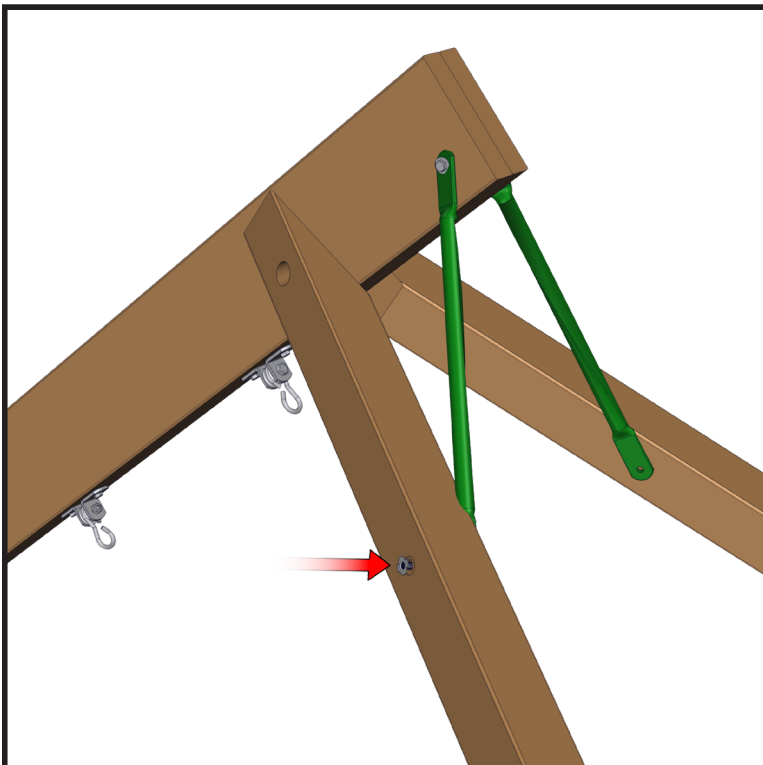

Step 10.

Place a T-Nut in the pre-drilled hole on the outside of each 4x4 post then use a hammer to set them into the wood.

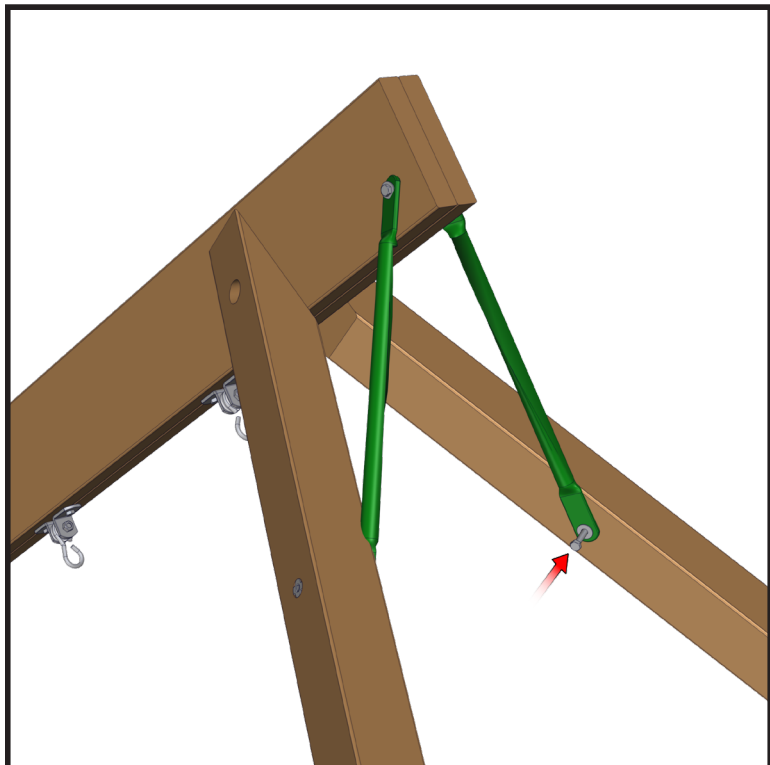

Step 11.

Fasten the swing braces to the 4x4 posts using a **3 1/2" bolt and washer** in the pre-drilled holes. The swing braces will need to be bent slightly using a rubber mallet.

After this step tighten all the bolts on the swing frame.

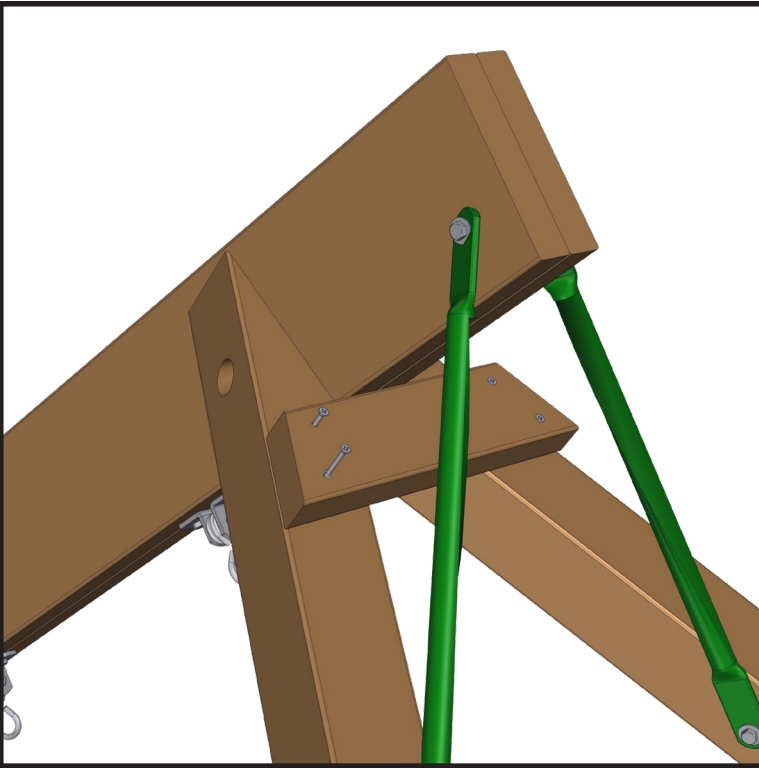

Step 12.
Place the 2x4 end piece on the 4x4 posts and line it up with the posts.
Fasten it with 3" wood screws.



Step 13.
Lift the swing frame up and place it on the tower next to one of the 4x4 posts.

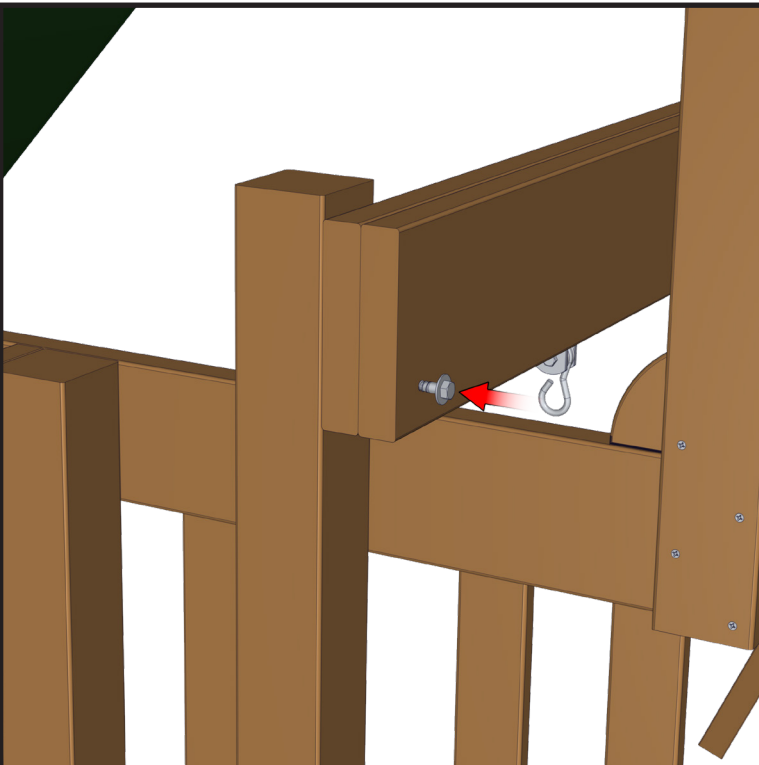

Step 14.
Fasten the swing beam to the 4x4 post using a hex head lag and washer through the pre-drilled hole in the swing beam.

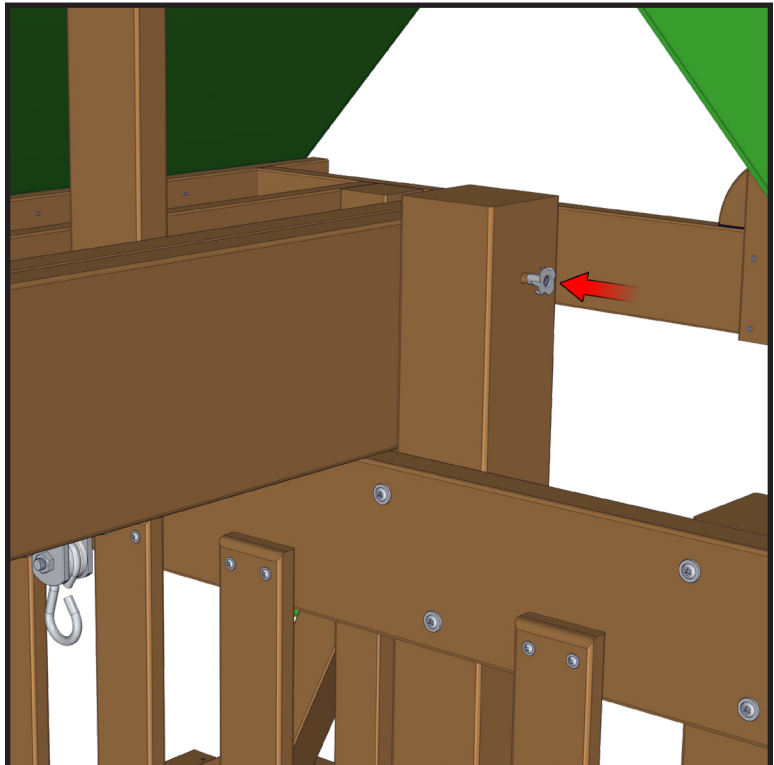

Step 15.
Drill a hole through the 4x4 post and swing beam using a $\frac{7}{16}$ " drill bit.
Place a T-Nut in the hole and set it with a hammer.

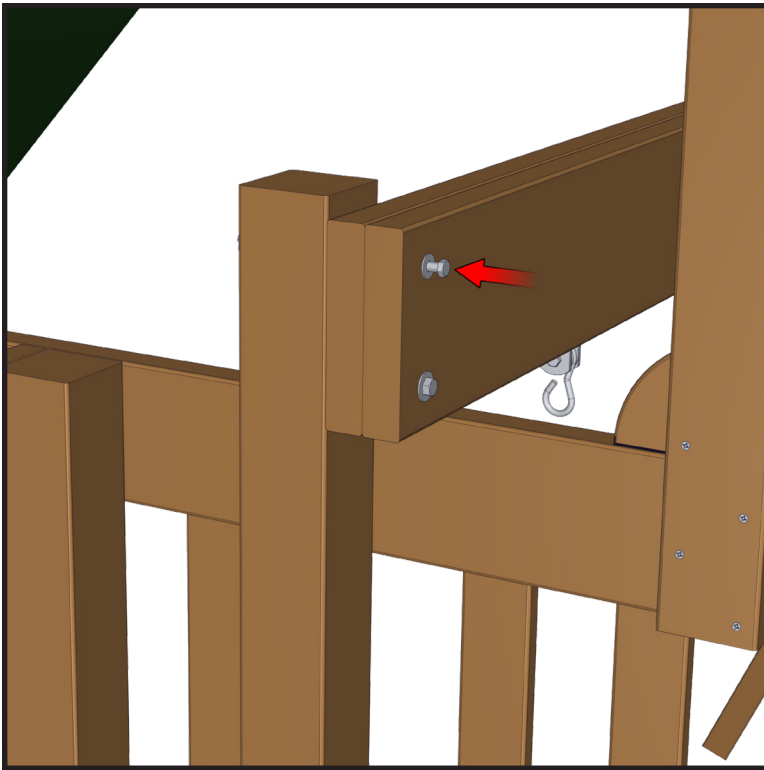

Step 16.
Fasten the swing beam to the post using a 6" bolt and washer through the hole.



Step 17.
Attach the rest of the swings to the swing bearings to finish the swing frame.

Space Saver Swing Frame



Note:
If your playset has a space saver swing frame the tower will have two extended 4x4's as shown in the illustration above.

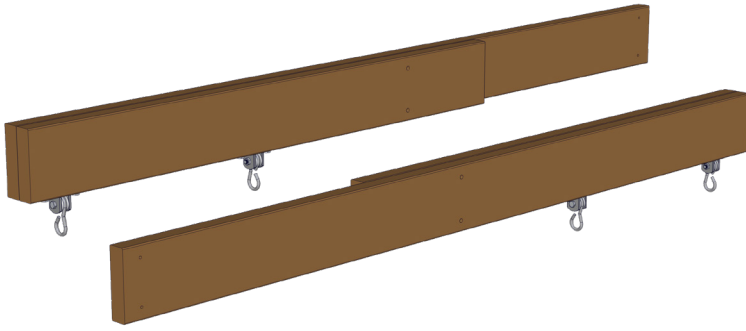

Step 1.
Locate the two swing beam sections.

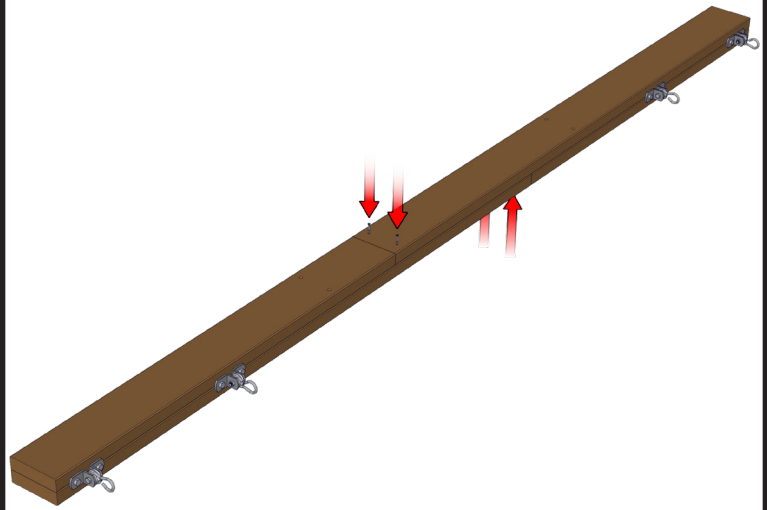

Step 2.
Place the two swing frame sections together and fasten them with four 2 1/2" wood screws.

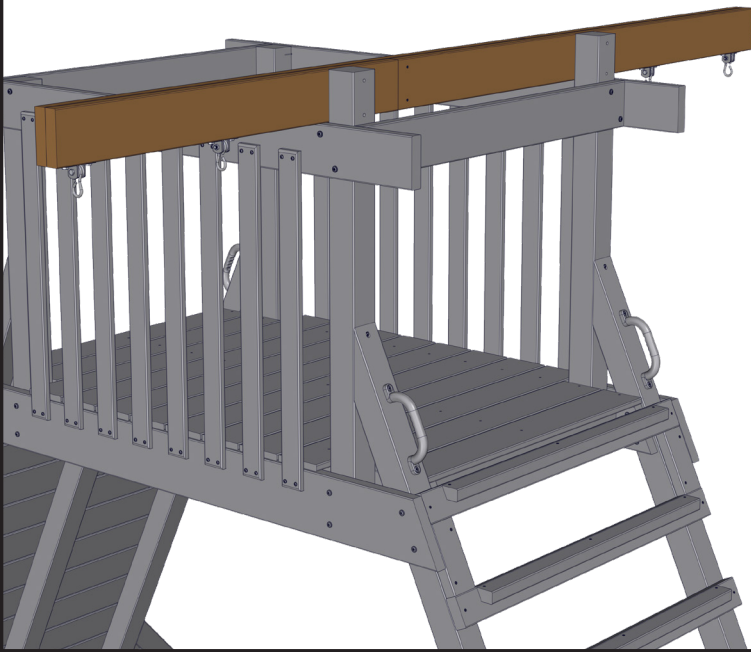

Step 3.
Place the swing frame on the tower against the inside of the extended 4x4 posts.

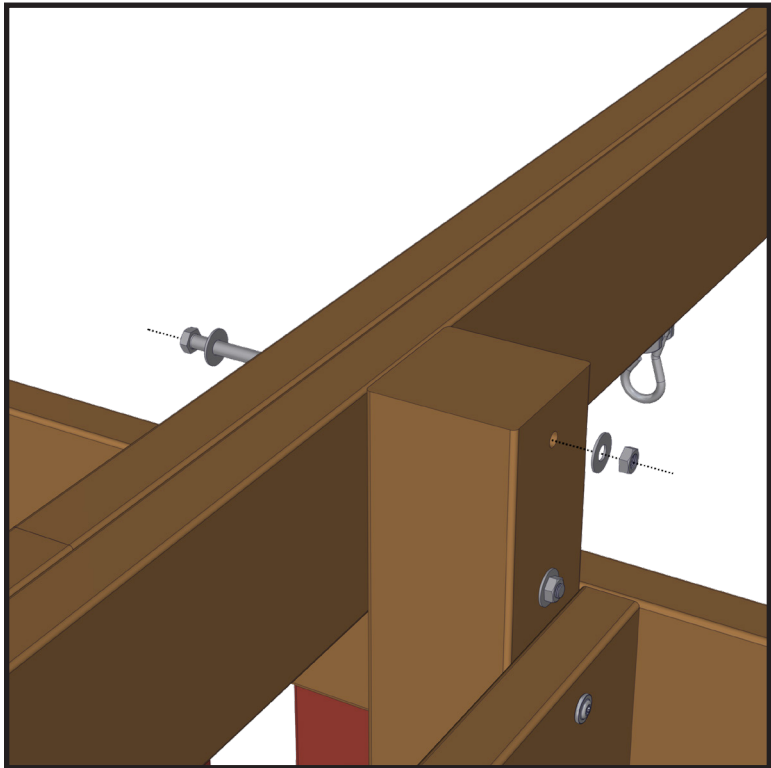

Step 5.
Fasten the swing beam to the 4x4 posts using four 6 1/2" bolts, washers and nuts.



Step 6.
Hang the swings from the swing beam to complete the space saver swing frame.

Accessories

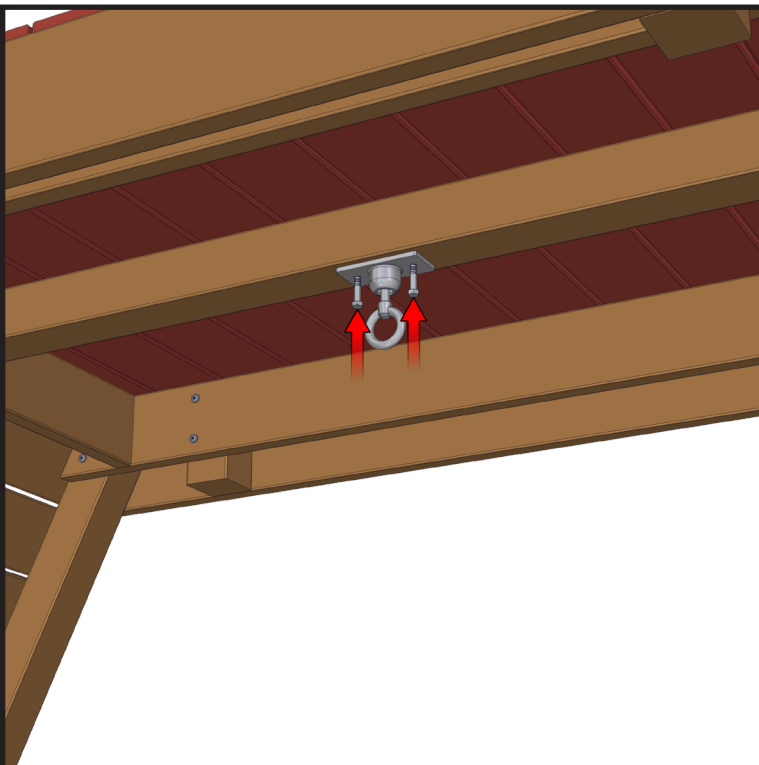

Tire Swing
Place the tire swing bracket on the center of the floor joist then fasten it with two hex head lags.



Tire Swing
Hang the tire swing chains from the brackets using the included chain quick link.



Wave Slide

Place the slide on the tower above the ladder.

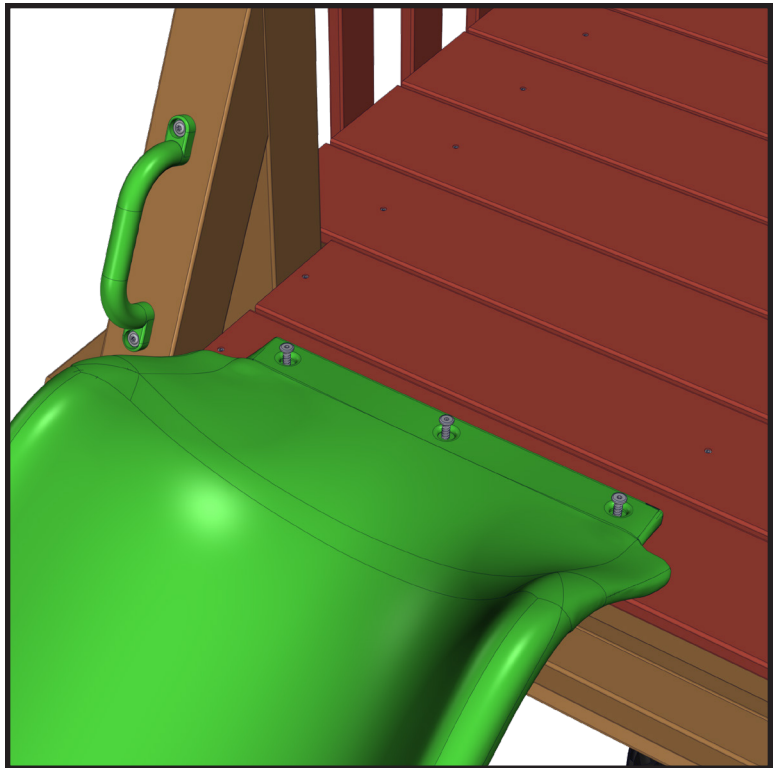

Wave Slide

Fasten the slide with 1 1/2" wafer head lags.

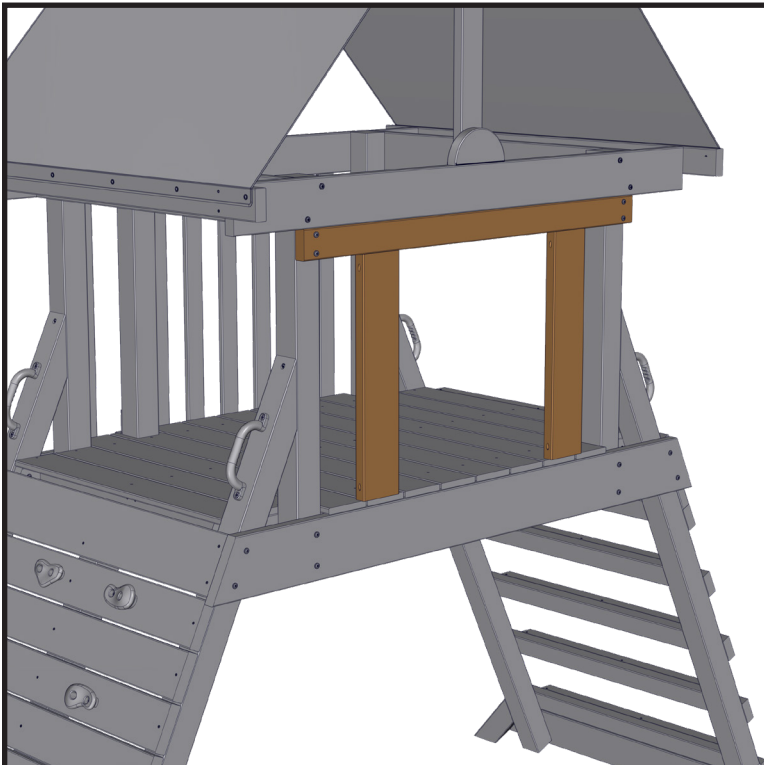

Sidewinder Slide

Place a 2x4 and two 2x6's in the opening to support the sidewinder slide.
 Measure the width of the mounting plate on the slide to determine the space between the 2x6's.
 Use 3" star head lags to fasten the 2x4 and 3" wood screws for the 2x6's.



Sidewinder Slide

Place the assembled slide on the tower and fasten it with the included hardware.

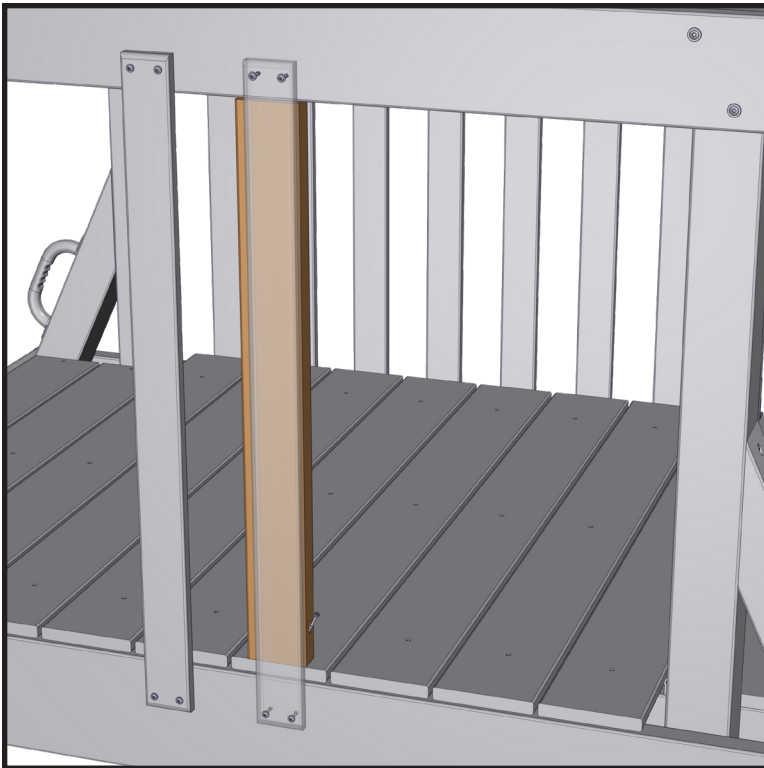

Wood Ladder

Place a 30 7/8" 2x4 behind one of the slats on the front of the playset. The opening should be 19 1/4" between the 2x4 and the 4x4.

Fasten the 2x4 by toe screwing it with 3" wood screws through the top and bottom.

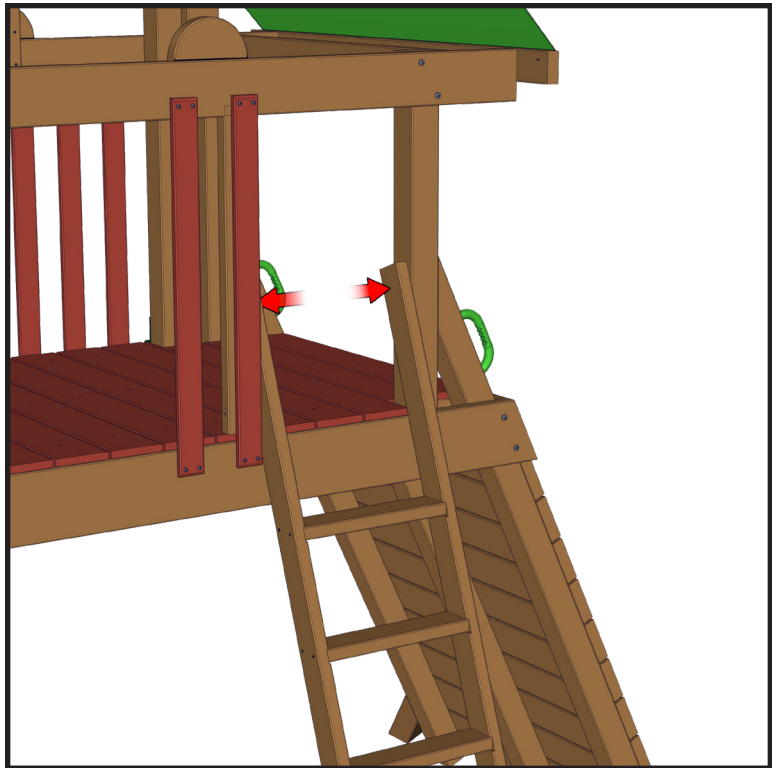

Wood Ladder

Place the ladder in position and fasten it with 2 1/2" wood screws.

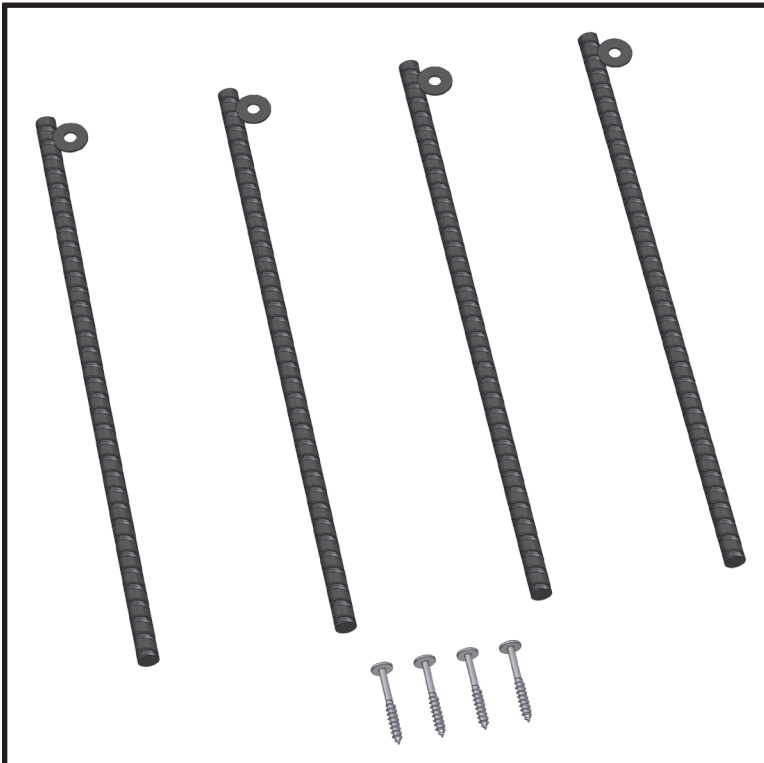

Playset Stakes

The playset comes with a bundle of stakes and hardware.



Playset Stakes

Drive the stakes into the ground at each corner of the playset and fasten them with the included lags.