



YardCraft[®]
rediscover life outdoors



POLY ADIRONDACK CHAIR ASSEMBLY MANUAL

Adirondack Chair Assembly Manual

Parts List

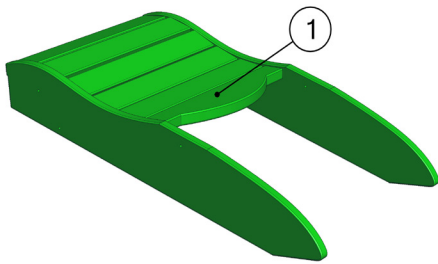

Seat Assembly

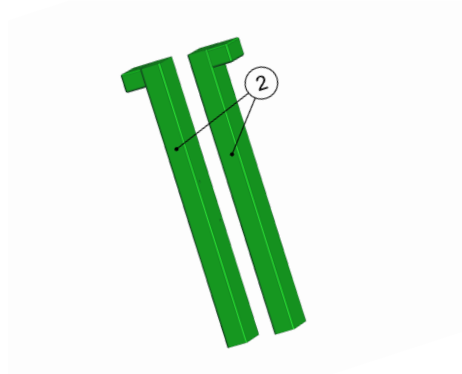

Legs

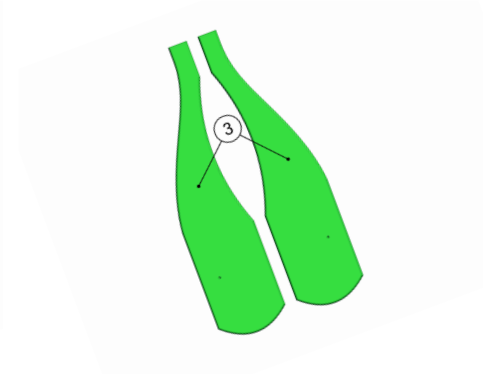

Arm Rest

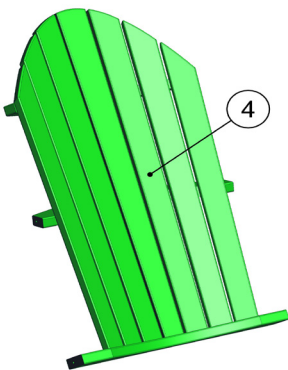

Back Assembly

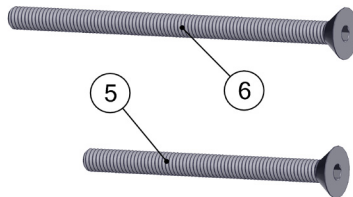

Hex Bolts

Description	Part#	QTY
Seat Assembly	1	1
Legs	2	2
Arm Rest	3	2
Back Assembly	4	1
1.5" Hex Bolt	5	6
2" Hex Bolt	6	4

Parts List

Tools Required For The Job (Included)



5/32" Hex Key

*NOTE: This Hex Key is used to tighten all the screws used in the assembly process.

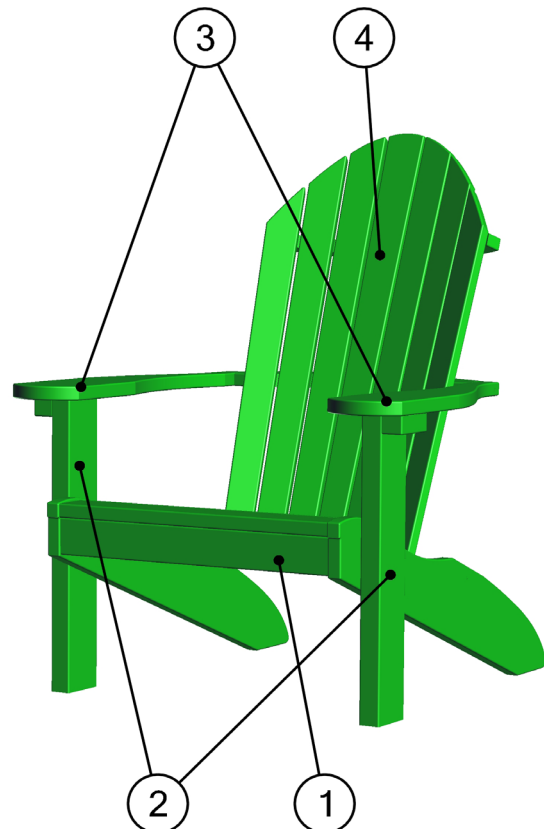

Adirondack Chair Assembly Manual

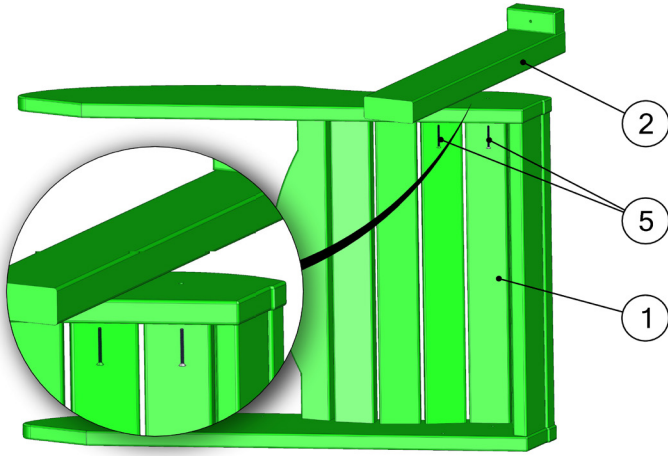

Start by placing the Seat Assembly on its side. Place one Leg onto the Seat Assembly. Fasten with two 1.5" Hex Bolts through the pre-drilled holes.

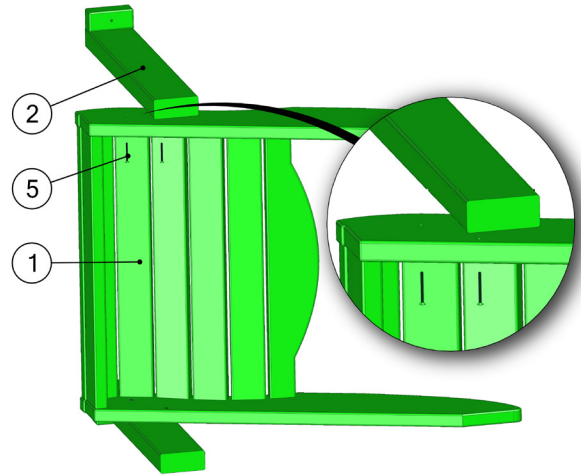

Turn the Seat Assembly around to install the second Leg with two 1.5" Hex Bolts through the pre-drilled holes.

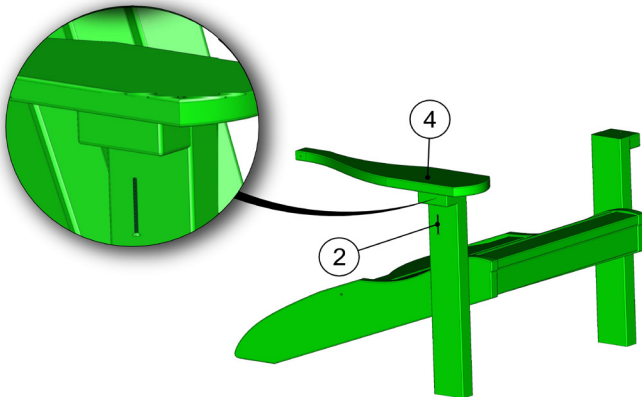

Set the Seat Assembly to its correct position. Place the Arm Rest onto the Legs and install one 2" Hex Bolt through the pre-drilled hole. (Only hand tighten for now.)

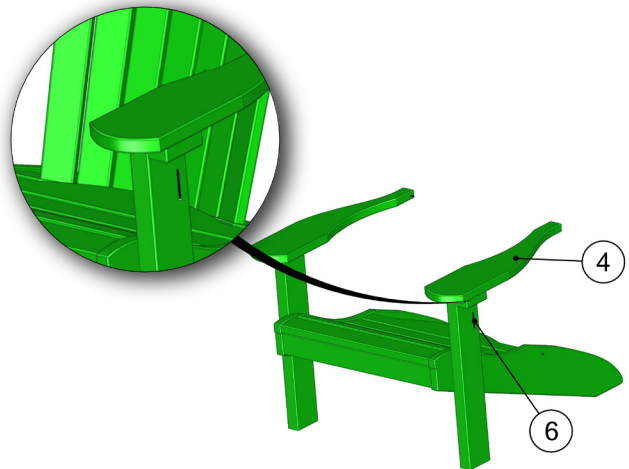

Place the second Arm Rest on the Leg on the opposite side, and install one 2" Hex Bolt through the pre-drilled hole. (Only hand tighten for now)

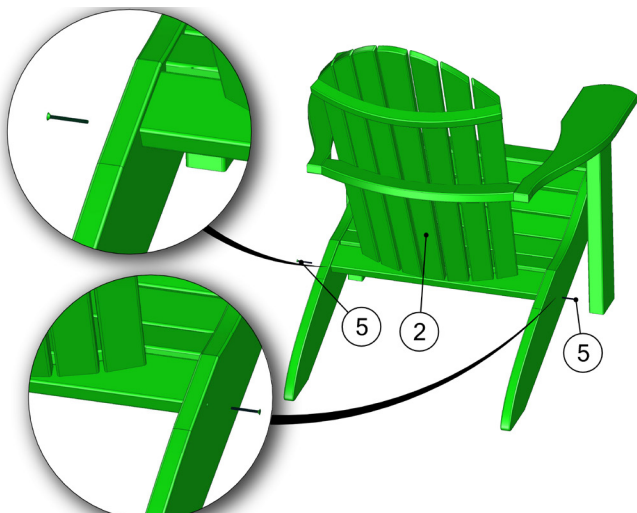

Place the Back Assembly between the Seat Assembly. Fasten to the Seat Assembly with 1.5" Hex Bolts through pre-drilled holes.

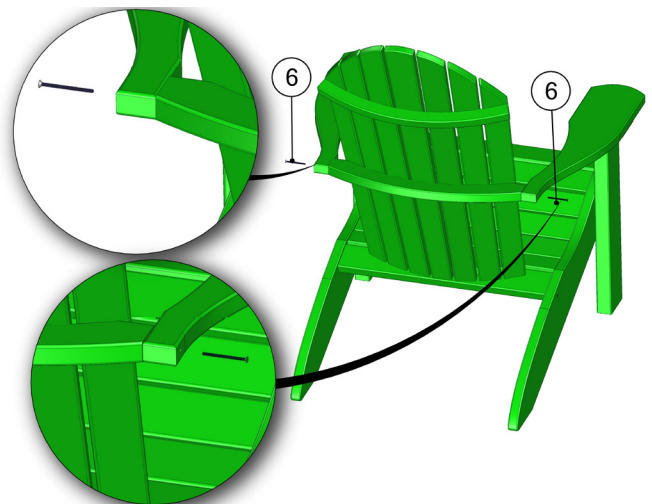

Fasten the two Arm Rest at each end of the Back Assembly with one 2" Hex Bolts through pre-drilled hole. Now using the provided Hex Key, tightly secure all the Hex Bolts.



YardCraft[®]
rediscover life outdoors

191 Jalyn Drive
New Holland PA 17557
1-844-442-1615
YardCraft.com
info@YardCraft.com